

GReddy Supercharger Kit

2003-ON Scion XB (NCP31)

MP45 Supercharger kit

GRReddy SUPERCHARGER KIT

SCION XB

Instruction Manual

Please read the manual carefully before installing and using this product.
This product is for off road use only.

MAKE	MODEL	CHASSIS	ENGINE	YEAR
SCION	XB	NCP31	1NZ-FE	2003-ON

- For OE air cleaner or GRACER AIRINX SET.
- This kit was designed for automatic transmission vehicles.



Important

This kit is designed for the vehicle specified above.
Please do not attempt to install this kit on other application.

Important

1. This installation should only be performed by a trained specialist who is very familiar with the automobile's mechanical, electrical and fuel management system.
2. If installed by an untrained person, it may cause damage to the kit as well as the vehicle.
3. GRReddy Performance Products Inc. is not responsible for any damage to the vehicle's electrical system caused by improper installation.
4. Make sure to follow the instruction and pay attention to the "Important", "Warning!" and "Caution!" notice through out the instruction.
5. Improper installation can be **dangerous!** Please make sure to inspect the installation before operating the vehicle.
6. Call your GRReddy Authorized dealer or GRReddy Performance Products if there are any problems or questions regarding this product.

1. Part List

1. Supercharger MP45	(W/Pulley)								1
2. Intake Manifold									1
3. Intake Tube									1
4. Alternator Pulley									1
5. Tensioner Pulley									1
6. Alternator Belt	(4PK-1270)								1
7. Supercharger Belt	(5PK-525)								1
8. Alternator Bracket									1
9. Tensioner Bracket									1
10. Tensioner Adjusting Bolt Assy									1
11. Spacer	18 φ × 10.7mm	(Tensioner)							1
12. "	16 φ × 102mm	(Supercharger)							1
13. "	18 φ × 20mm	(Tensioner Bracket)							2
14. Oil Dip Stick Bracket									1
15. Intake Tube Bracket									1
16. Hose Union	6 φ - 1/8PT								1
17. Vacuum Hose	6 φ × 300mm								1
18. Hose Band	6 φ								2
19. Cable Tie	150mm								10
20. E-manage	(SC US-xB)								1
21. E-manage Harness	(T-21改xB)								1
22. Tensioner Bolt									1
23. 6 × 15mm	P1. 0	Stainless	B	S/W	—	N	(Oil Dip Stick Guide)		1
24. 6 × 40mm	P1. 0	Stainless	B	S/W	—	—	(Tensioner Bracket)		2
25. 8 × 15mm	P1. 25	Stainless	B	S/W	—	—	(Intake Tube Bracket)		1
26. 8 × 25mm	P1. 25	Stainless	B	S/W	—	—	(Supercharger IN)		4
27. 8 × 30mm	P1. 25	Stainless	B	S/W	—	N	(Supercharger OUT)		4
28. 8 × 35mm	P1. 25	Stainless	B	S/W	F/W	—	(Throttle)		2
29. 8 × 38mm	P1. 25	Stainless	B	S/W	—	N	(Intake Manifold)		3
30. 8 × 40mm	P1. 25	Stainless	B	S/W	—	—	(Tensioner Bracket)		2
31. 8 × 160mm	P1. 25	Stainless	B	S/W	—	—	(Supercharger)		1
32. M10	P1. 25	Nut	—	—	—	N	(Tensioner Pulley)		1

Part List Diagrams/Pictures



1

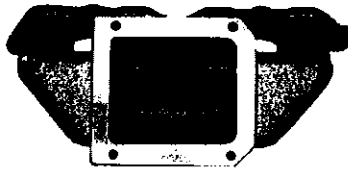

2

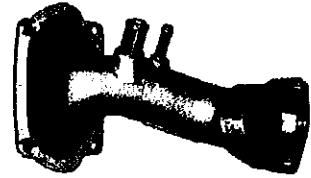

3



4



5

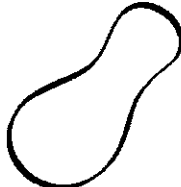

6



7

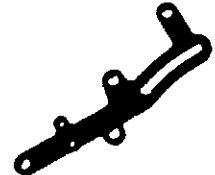

8



9



10



11



12



13



14



15

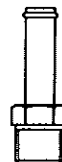

16

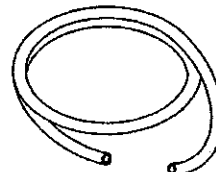

17



18

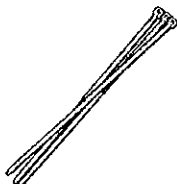

19

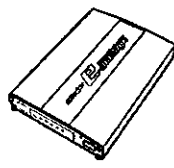

20



21



22

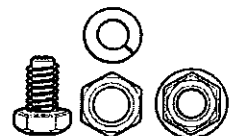

23~32

2. Stock Component Removal

When removing OE components, please refer to manufacture repair manuals for specifications and procedures.

2-1 Disconnect battery (-) terminal.

2-2 Remove the right and left side engine undercover.

2-3 Drain the coolant from the radiator by removing the radiator drain plug.

2-4 Remove the cylinder head cover No. 2, front grill, hood latch, and support brace (see pic on right).

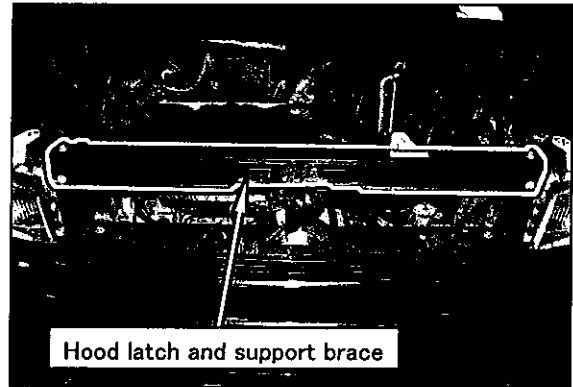

2-5 Remove the fresh air intake, air cleaner box, air cleaner hose No.1, and Ventilation hose No.2.

2-6 Remove the accelerator control cable assembly, vapor feed hose, water bypass hose No.1 & 2, and disconnect harness connector on throttle body. Remove throttle body.

※ Before removing the throttle body, remove the ATF dipstick guide bolt (M6) and move the level dipstick guide to the side.

※ Mark the water bypass hoses to prevent miss matching when installing back onto the throttle body.

2-7 Remove the intake manifold and engine oil dip stick assy.

2-8 Remove the right side air bag sensor.

2-9 Remove the alternator belt, alternator bracket, and alternator assy.

3. Kit Installation

3-1 KIT Alternator Pulley Installation

- (1) Remove the stock alternator pulley and install the Greddy pulley.
- ※ Re-use the stock pulley nut and apply thread lock before installing the nut

Torque Spec : 100. 0 N·m(10. 2kg. m)

〈Part No.4〉

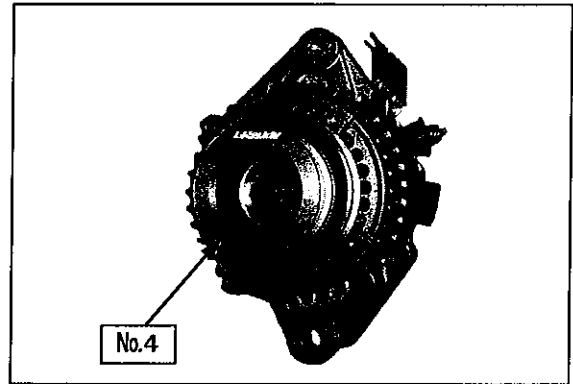

- (2) Use the OE bolt to install the alternator. Make sure the wires and harness are properly connected
- ※ Only use the bottom bolt to install the alternator at this time.
- (3) Install the air bag sensor that was removed in figure 2 - 8 using the same OE bolts and location mounting location.

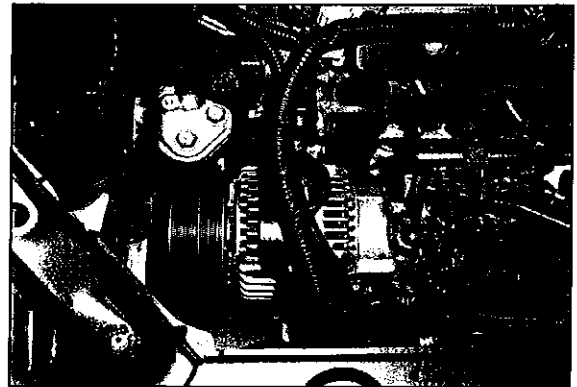

3-2 KIT Supercharger Assembly

- (1) Remove the supercharger bolt that the picture on the right is pointing to.

〈Part No.1〉

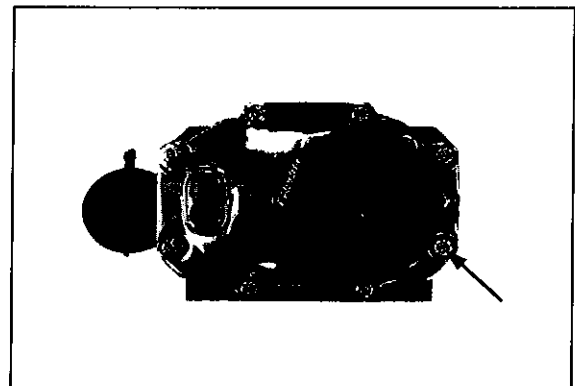

- (2) Install the 1/8 PT 6 ϕ hose union fitting on the intake manifold.
- ※ Wrap the threads with sealing tape.

〈Part No.2, 16〉

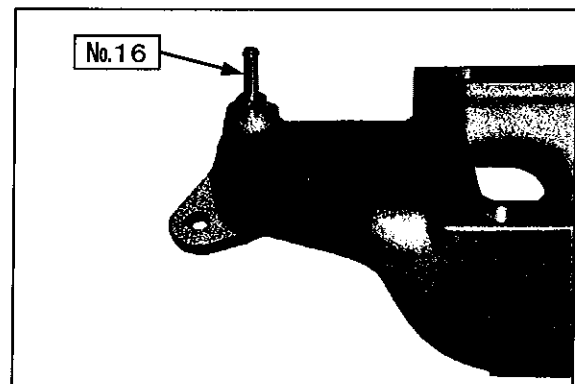

(3) Install stud bolts on the supercharger outlet flange (square flange) and apply silicone sealant onto the flange surface. Attach intake manifold to supercharger.

※ Be careful not to let sealant protrude from the inner section of the flange.

※ The oil dipstick bracket will be installed later. Please leave this nut finger tight.

〈Part No.27〉

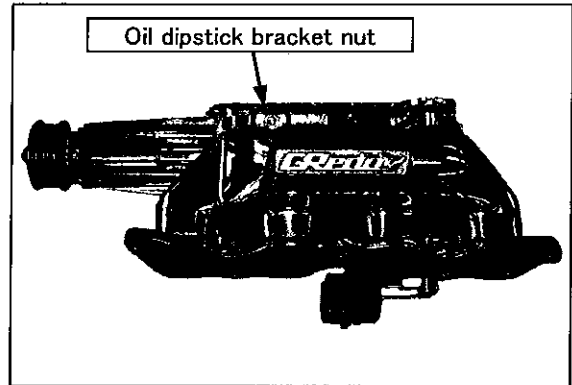

3-3 S/C Installation

(1) Install three M8 studs into the center thread holes on the head shown on the picture to the right.

〈Part No.29〉

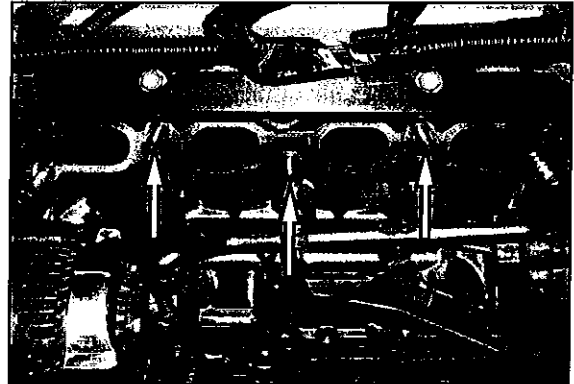

(2) After installing the S/C, make sure there is enough clearance between the upper radiator hose and S/C.

※ If there is less than 5 mm of clearance, cut the section shown until you have 5-10 mm of clearance.

※ If cutting the housing, make sure to cover the ports to prevent materials from entering.



Please use safety glasses and a mask to prevent injury.

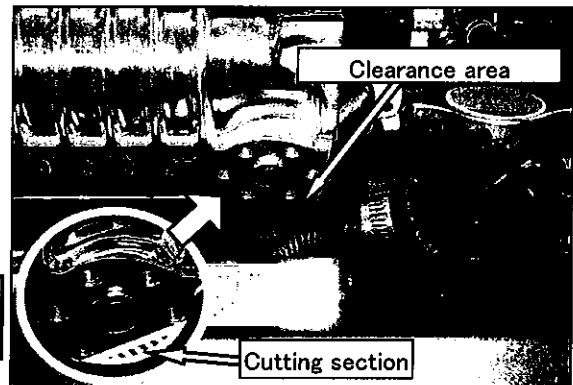

(3) Apply silicone sealant to the intake manifold flange and install supercharger assy to the engine.

※ Be careful not to let any sealant protrude into the intake manifold ports.

※ Re-use the outer OE intake manifold studs and nuts.

〈Part No.29〉

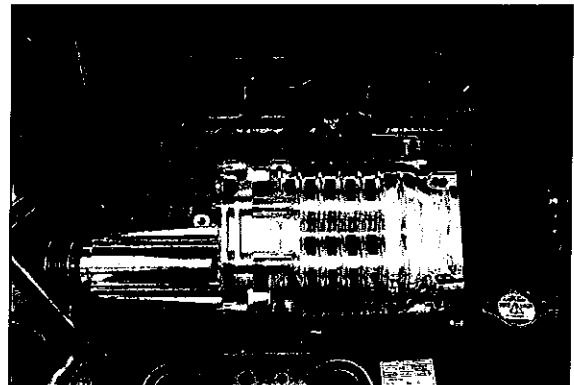

- (4) Remove the OE wire harness clamp and use cable ties to strap harness to the fuel delivery pipe
- ※ Make sure there is clearance between the actuator rod and wire harness by pushing the rod inward.

〈Part No.19〉

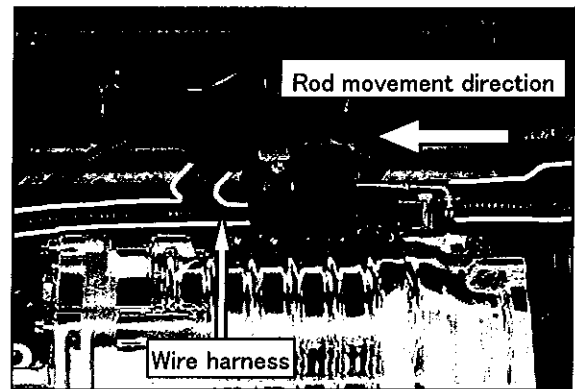

3-4 Oil dipstick guide installation

- (1) Attach the dipstick bracket onto the guide using and M6 bolt and nut.

〈Part No.14, 23〉

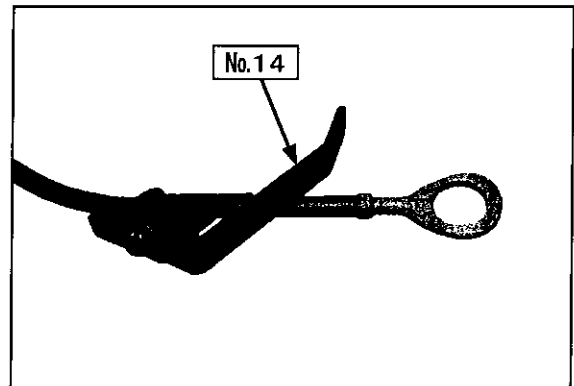

- (2) Install the dipstick guide onto the engine and attach the guide bracket onto the square supercharger flange.

- ※ Insert dipstick and adjust for clearance while tightening the bracket bolts. Tighten from the supercharger first.

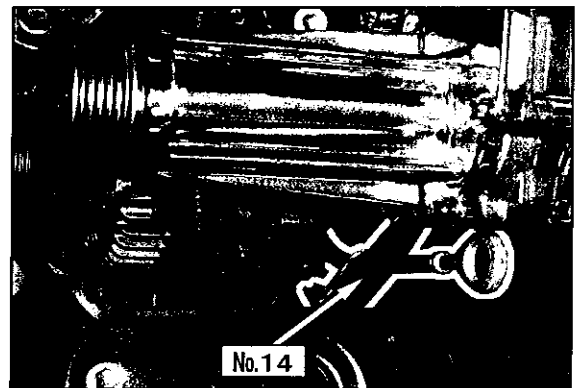

3-5 KIT Alternator Bracket Installation

- (1) Install the new alternator bracket, using the same location for the OE bracket. Lightly tighten the alternator upper bolt.

- Use OE bolts on the engine side of the bracket.
- Place the 16 ϕ spacer between the bracket and the supercharger and replace bolt that was removed in 3-2(1) with the M8x160mm bolt.

- ※ Lightly tighten alternator upper bolt so it still can slide freely to be adjusted later.

〈Part No.8, 12, 31〉

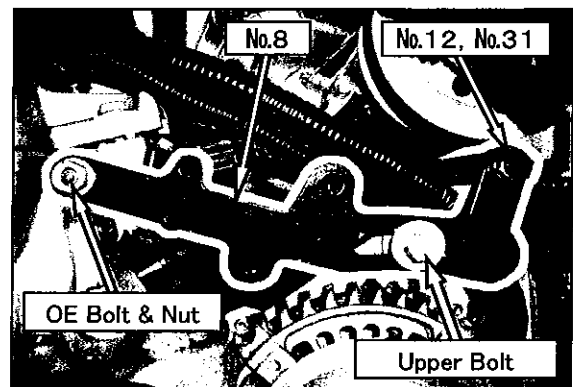

※ Use thread lock on the M8 x 160mm bolt.

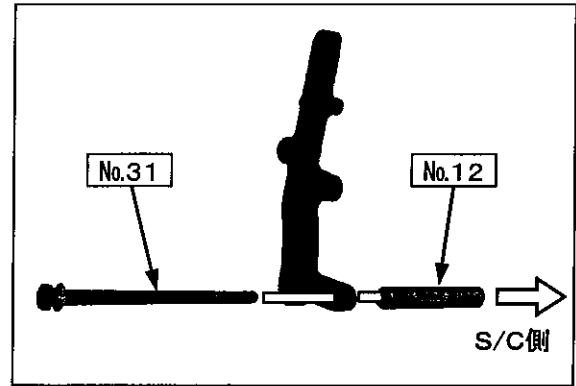

3-6 KIT Belt Installation

- (1) Place the belt around the crank pulley and alternator pulley (large side). Do not place the belt around the water pump pulley yet.

〈Part No.6〉

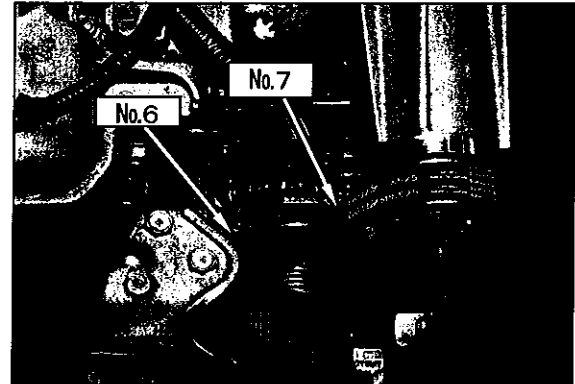

- (2) Pull the alternator towards the front of the vehicle and place the No. 7 belt around the alternator pulley (small side) and supercharger pulley. Now you may place the belt around the water pump pulley.

※ If you place the belt around the water pump pulley first, you will not be able to adjust the alternator to install the supercharger pulley belt.

〈Part No.7〉

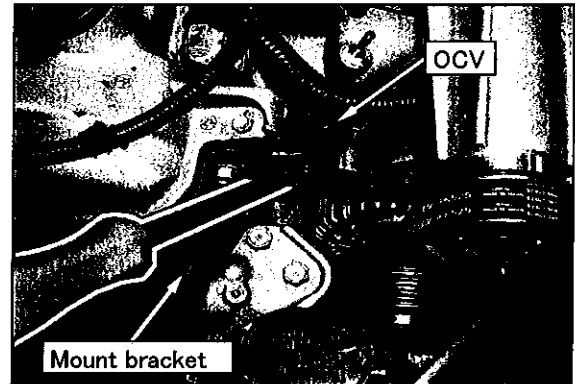

- (3) Place tension on the belt and secure alternator.
 - ※ Place a pry bar between the alternator and engine mount bracket. Use the pry bar to push the alternator forward to place tension on the belts.
 - ※ Make sure the OCV (oil control valve) is not damaged when using the pry bar to apply pressure.

- (4) Make sure the belt has the proper amount of tension.

Alternator bolt torque specs.

- Ⓐ ... 18.5N·m [185kgf·cm]
- Ⓑ ... 54.0N·m [550kgf·cm]

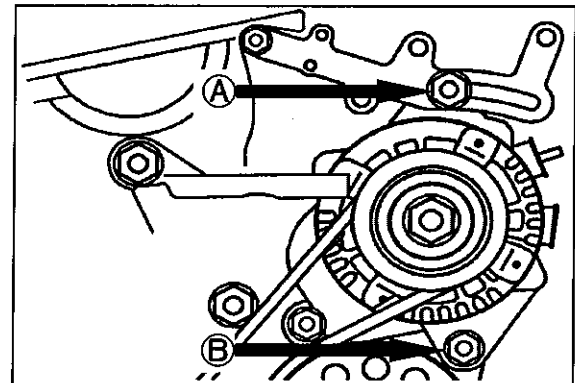

Belt play check

	New	Used
Tension [98N{10kgf}]	7~8.5mm	11~13mm

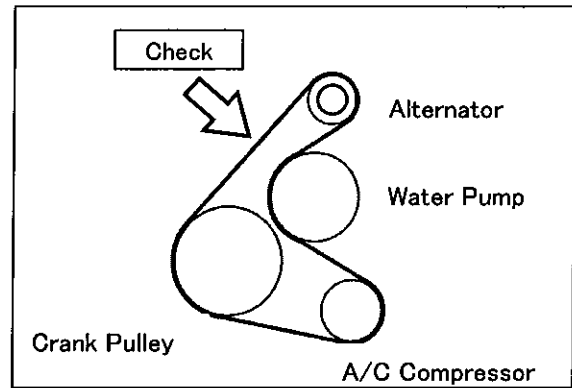

3-7 KIT Tensioner Installation

(1) Put the tensioner bolt through the adjuster Assy like the picture on the right.

- ※ Make sure the adjuster bolt and bracket are parallel to each other.
- ※ Make sure the tensioner bolt is assembled in the proper directions.

〈Part No.9, 10, 22〉

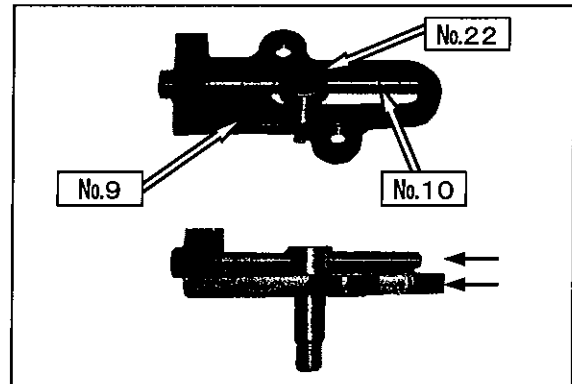

(2) Use the 18φ × 20mm spacer to install the tensioner bracket onto the alternator bracket.

- ※ Install the M6 bolt going from the tensioner bracket and the M8 bolt going from the alternator bracket.
- ※ Please use thread lock on these bolts.

〈Part No.13, 24, 30〉

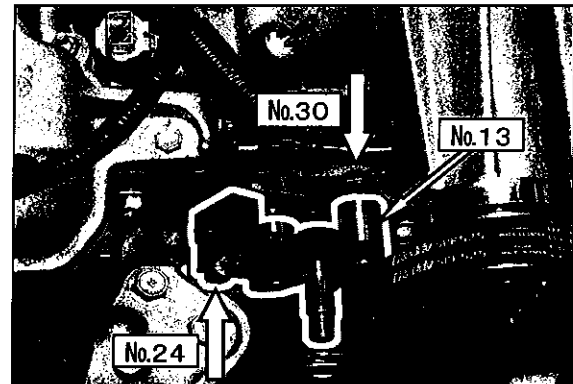

(3) Place the 18φ × 10.7mm spacer between the tensioner pulley and the bracket and use the M10 nut on the opposite side of the pulley.

〈Part No.5, 11, 32〉

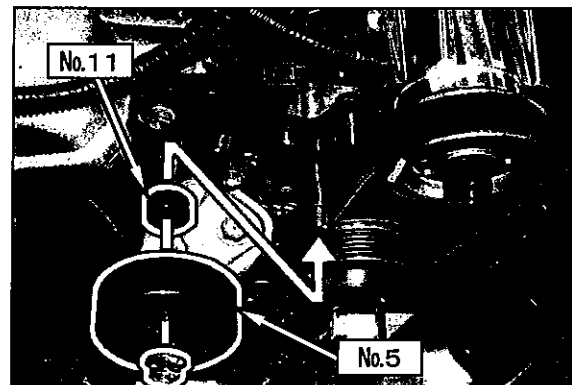

- ※ Place the rim side of the pulley facing the tensioner bolt side.

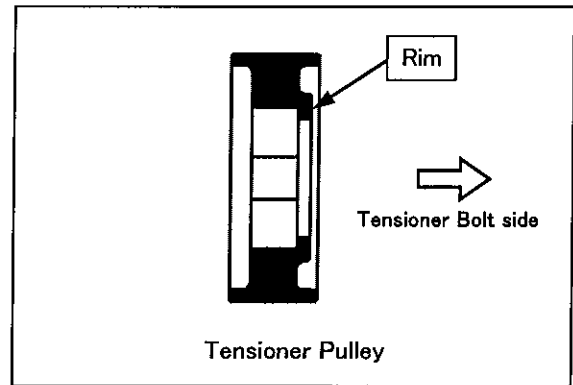

- Rotate the tension adjuster bolt until the belt has the proper amount of tension and torque the M10 nut holding the pulley in place.
- ※ Do not over-tighten the pulley belt, as the adjuster bolt E ring may be damaged.

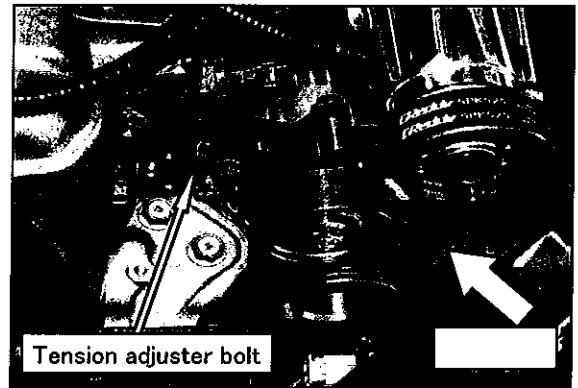

Belt play check

	New	Used
Tension [98N{10kgf}]	7~8.5mm	11~13mm

3-8 KIT Vacuum hose route

- Use a 6φ hose to connect from the actuator to the intake manifold hose union. Please use hose bands.
- ※ Safely route the vacuum hose and secure the hose with cable ties.

〈Part No.17, 18, 19〉

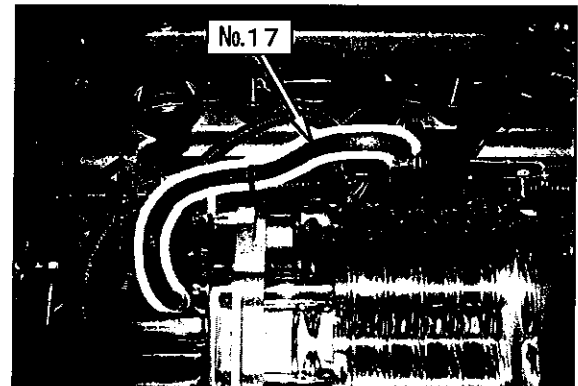

3-9 KIT Intake Tube Installation

- (1) Remove the transmission bolt below the engine water tube and attach the 11 ϕ mm side of the intake tube bracket to the transmission using the same bolt.

〈Part No.15〉

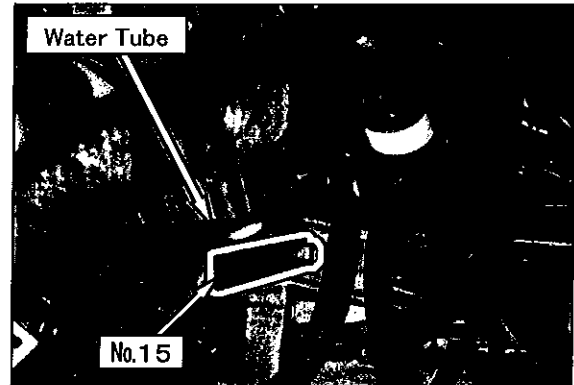

- (2) Place silicone sealant on the flange of the supercharger inlet and attach the intake tube to the supercharger with the provided bolts.

※ Do not let any sealant protrude to the inside of the flange.

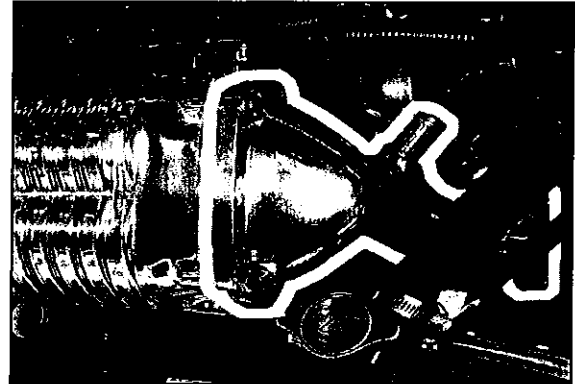

- (3) Attach the other side of the intake tube bracket to the intake tube flange connecting to the throttle body.
- ※ After lightly tightening both bolts, torque the two bracket bolts, starting from the transmission side.

〈Part No.3, 25, 26〉

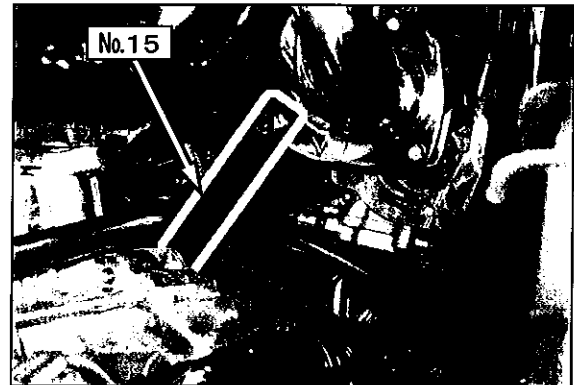

- (4) Insert the booster vacuum hose onto the 10 ϕ mm tube and the blow by hose onto the 19 ϕ mm tube.

※ Route the blow by hose outside of the wire harness.

※ Use the OE hose bands for these hoses.

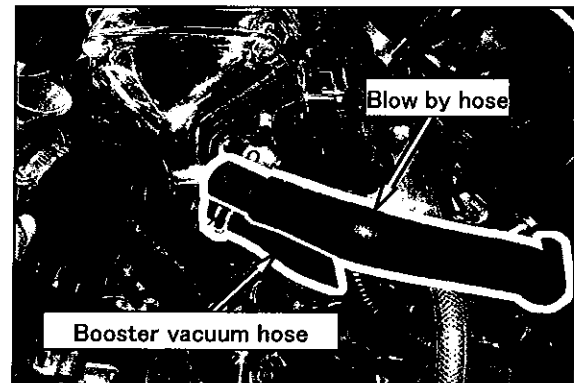

(5) Coat the throttle body flange with silicone sealant and use on OE bolt and two provided bolts to attach the throttle body to the intake tube.

※ Do not allow sealant to protrude into the inside of the throttle opening.

〈Part No.28〉

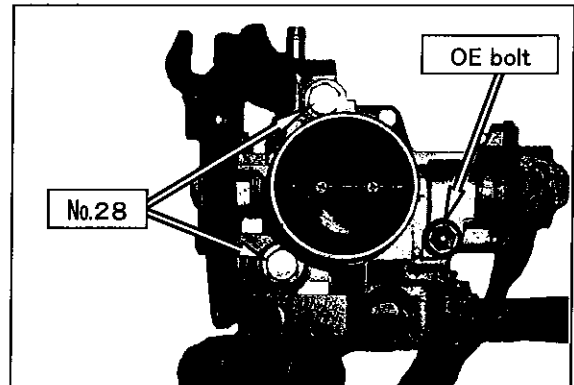

(6) Attach the water bypass hose No. 1,2 and throttle control cable assy to the throttle body. Also attach the vapor feed hose and harness connectors (idle speed control, TPS) to the throttle body.

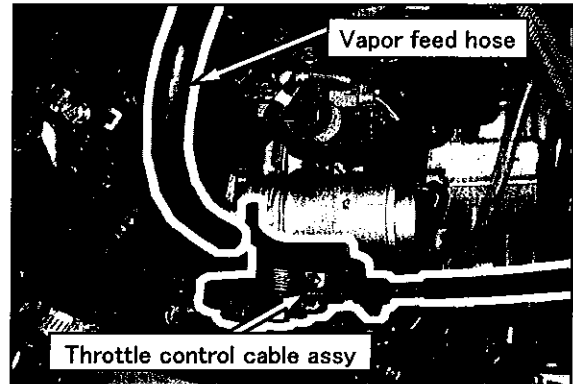

(7) Install the ATF dipstick back to its original position.

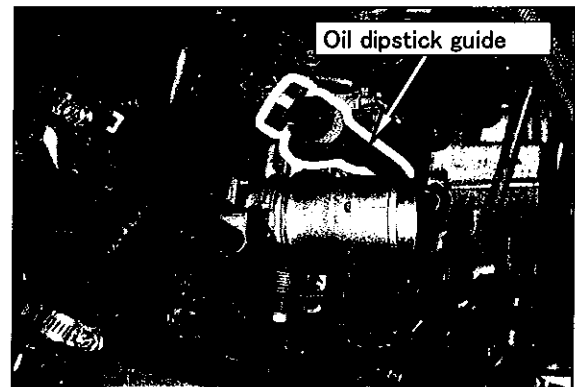

(8) Install the OE air cleaner case, air cleaner hose No.1, cool air intake, and ventilation hose No.2. Use OE hose bands.

※ When using the AIRINX intake system, please refer to the AIRINX instruction for installation.

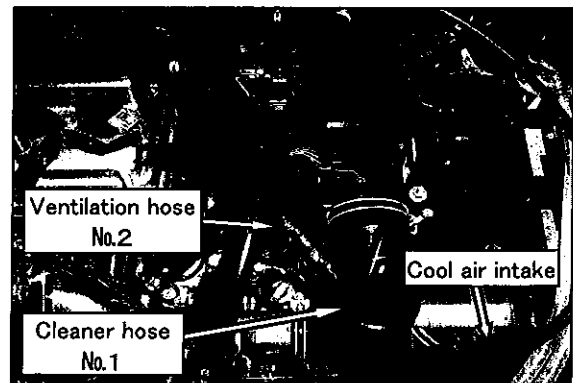

3-10 KIT e-manage installation

- (1) Remove the ECU harness cover located under the passenger side glove box. Unplug the OE ECU harness from the ECU and plug in the e-manage patch harness between the ECU and OE harness.
Secure the e-manage.

- ※ Secure the e-manage in an area that is cool and dry to prevent overheating or damage.
Avoid securing the e-manage under carpet or floor mats.

〈Part No.20, 21〉

- (2) Secure the harness and install the ECU harness cover.

〈Part No.19〉

3-11 Engine startup

- (1) Add coolant to radiator and bleed the air from the cooling system.
- (2) Check the hose and wire connections and attach the batter (-) terminal.
- (3) Turn the ignition key on and check to see if the e-manage ACTIVE LED is green.
- (4) Start the engine and check all connections for leaks or problems.
Also check the ACTIVE LED on the e-manage for error.
 - ※ If the ACTIVE LED is flashing red, refer to the e-manage section.
 - ※ Make sure the actuator rod does not touch the engine harness when moving. [3-3(4)]
- (5) Check to make sure there are no oil, water, or vacuum leaks around the engine while idling.
- (6) Install the engine under covers, hood latch support brace, and front grill.
- (7) Cut the stock head cover No.2 to clear the supercharger and install the piece onto the engine.

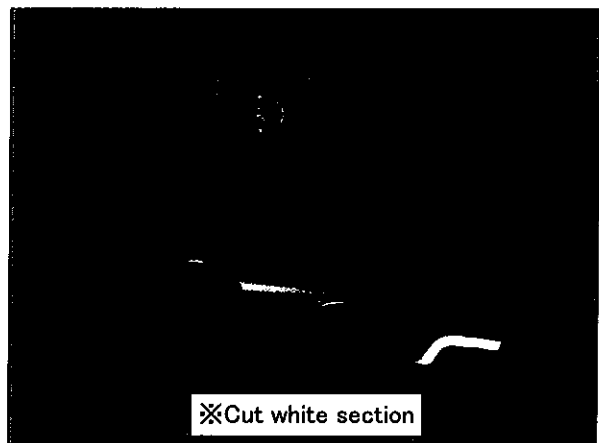
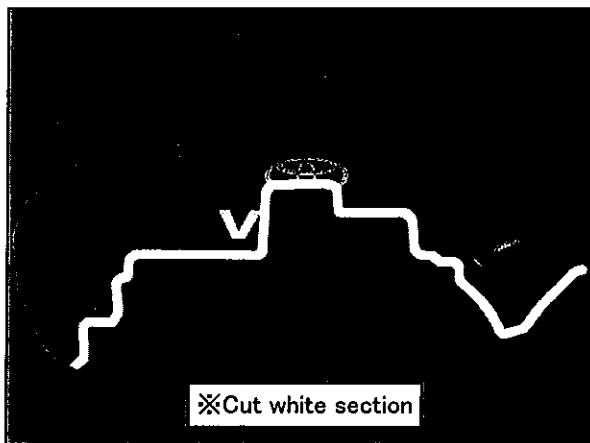

This completes the Supercharger Kit installation.

IMPORTANT

- It is very important that you monitor the boost pressure, and make sure not to over boost. Over boosting can cause engine damage.
- GReddy Performance Products, Inc. is not responsible for any engine damage caused by over boosting (increased boost), modification to the kit, and/or misuse of the product. **NO WARRANTY** is offered.
- Due to lack of control over proper installation and use of this product, **NO WARRANTY** is offered for this kit.

4. Power Data

○ This kit is designed to create 58.8kpa(0.6kgf/cm²) of boost pressure.

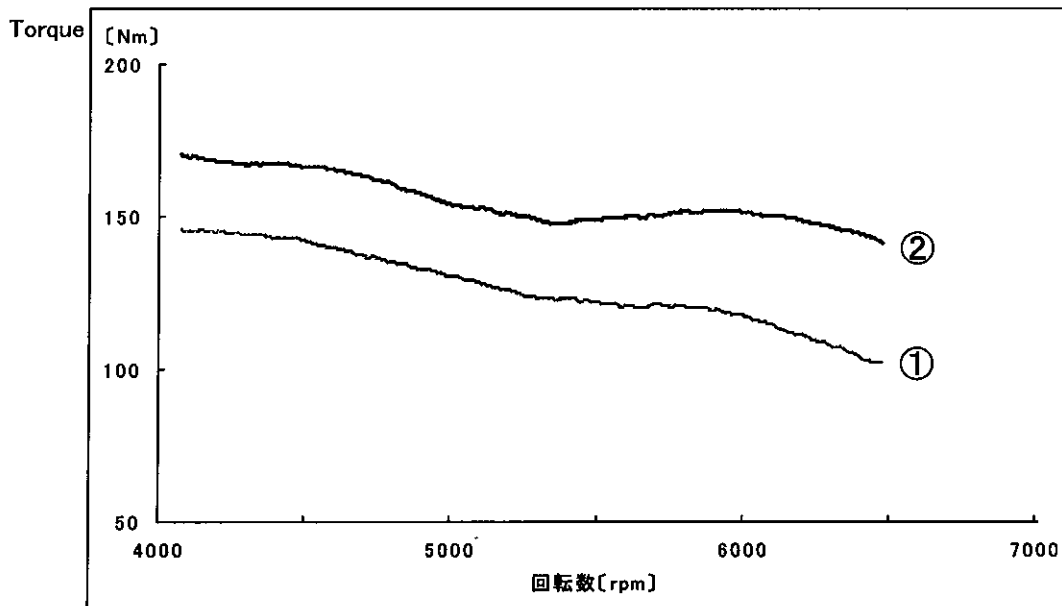
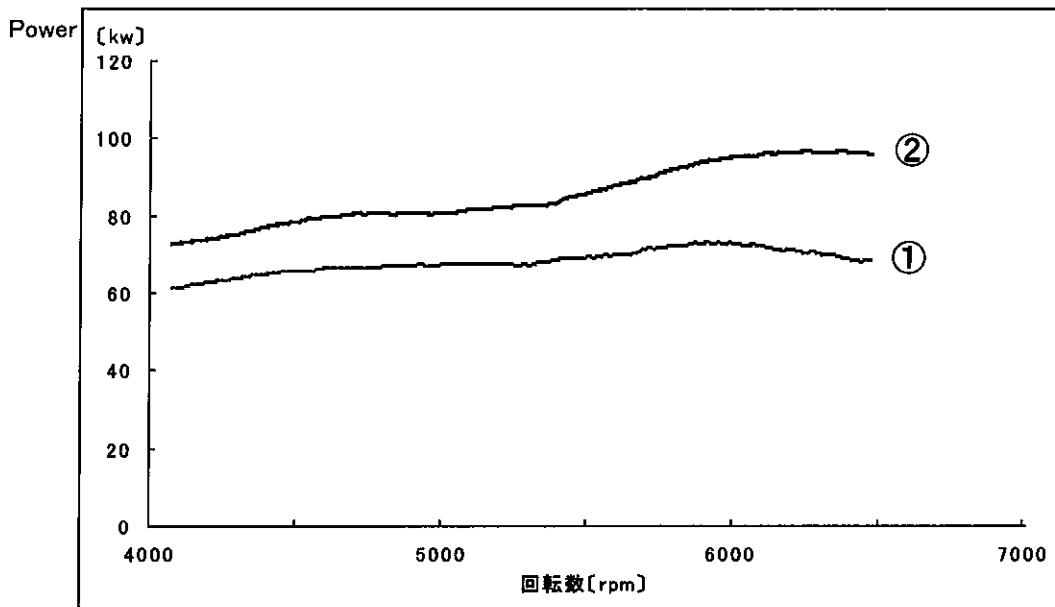

仕様	Power kw(ps)/rpm	Torque Nm(kg·m)/rpm
① Stock	74.4(101.2)/5860	145.5(14.8)/4100
② S/C Kit + AIRINX Boost 58.8kpa (0.6kg/cm ²)	96.7(130.1)/6240	170.1(17.3)/4100

※ This Data was taken at the TRUST factory.

Differences in air temperature and elevation may cause data to be different.

This data was taken with an AT transmission at WOT from 100km/h(3800rpm) without any gear kick down.

e-manage Information

Important!

- The e-manage included in this kit is preprogrammed for this turbo kit.
- Do not attempt to adjust any of the setting in the e-manage.
- Any adjustments made can cause damage to the e-manage, engine and the factory ECU.

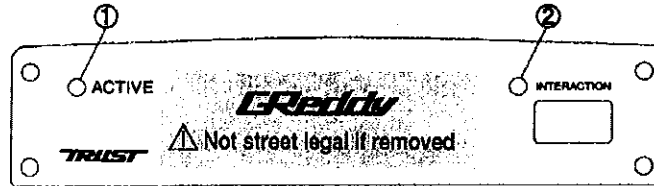

Important!

As of 12/30/04 this kit is not a street legal kit. Please ignore the label on the e-manage.

① ACTIVE L.E.D.

1. When the ignition is turned on, it will illuminate and flash GREEN.
2. When it reaches to the A.A.V. setting RPM range, it will illuminate and flash ORANGE.
3. When an error is detected it will flash RED.

② INTERACTION L.E.D.

1. This will illuminate when there is a connection with PC.

Checking Error Codes

When the unit is powered up and if there are any errors, the ACTIVE L.E.D will turn "RED" from "GREEN", and begin to flash.

If this happens shut the engine off and turn the ignition switch to "ON" position to go to Self Troubleshooting Mode. While in the Self Troubleshooting Mode, the L.E.D. will show the error code. Turn off the ignition. Check the error code in the chart below and fix the problem. The error code will show until the error is corrected.

CODE	Error	Error description
11	Airflow Signal 1 input error	Incorrect wiring or disconnected Airflow Signal 1
15	Airflow voltage output error	Incorrect Airflow signal output wiring.
20	No injector pulse from all	Not receiving an injector signal for Additional Injection Map
21	No injector 1 pulse	Not receiving injector signal I/J CH-1 for Additional Injection Map
22	No injector 2 pulse	Not receiving injector signal I/J CH-2 for Additional Injection Map
23	No injector 3 pulse	Not receiving injector signal I/J CH-3 for Additional Injection Map
24	No injector 4 pulse	Not receiving injector signal I/J CH-4 for Additional Injection Map
31	Incorrect injector 1 pulse	Incorrect I/J CH-1 wire to e-Manage unit
32	Incorrect injector 2 pulse	Incorrect I/J CH-2 wire to e-Manage unit
33	Incorrect injector 3 pulse	Incorrect I/J CH-3 wire to e-Manage unit
34	Incorrect injector 4 pulse	Incorrect I/J CH-4 wire to e-Manage unit
40	Improper order of ignition input signal	Incorrect wiring order of the ignition signal wires.
41	No Ignition Signal 1 pulse	Not receiving the Ignition signal to IG CH-1
42	No Ignition Signal 2 pulse	Not receiving the Ignition signal to IG CH-2
43	No Ignition Signal 3 pulse	Not receiving the Ignition signal to IG CH-3
44	No Ignition Signal 4 pulse	Not receiving the Ignition signal to IG CH-4
49	No Ignition pulse	Not receiving the Ignition signal to any of the channels
51	Incorrect Ignition 1 pulse	Incorrect IG CH-1 wire to e-Manage unit
52	Incorrect Ignition 2 pulse	Incorrect IG CH-2 wire to e-Manage unit
53	Incorrect Ignition 3 pulse	Incorrect IG CH-3 wire to e-Manage unit
54	Incorrect Ignition 4 pulse	Incorrect IG CH-4 wire to e-Manage unit
57	J#2 + 12V error	Incorrect Jumper setting (J#2)

